



THE DISPLAY CHOICE
OF PROFESSIONALS™

www.agneovo.com

PO-5502 LCD Display
User Manual

TABLE OF CONTENTS

SAFETY INFORMATION	1
CE Declaration of Conformity	1
Polish Center for Testing and Certification Notice	1
Electric, Magnetic and Electromagnetic Fields (“EMF”)	2
Information for U.K. only.....	2
North Europe (Nordic Countries) Information.....	4
End-of-Life Disposal	4
Waste Electrical and Electronic Equipment-WEEE.....	4
Turkey RoHS.....	6
Ukraine RoHS	6
PRECAUTIONS	7
Cautions When Setting Up	7
Cautions When Using.....	8
Cleaning and Maintenance.....	8
Notice for the LCD Display	9
CHAPTER 1: PRODUCT DESCRIPTION.....	10
1.1 Package Contents	10
1.2 Moving the Display	11
1.2.1 Unpacking the Display.....	11
1.2.2 Carrying the Display	11
1.2.3 Setting Down the Display	11
1.3 Wall Mounting Installation.....	12
1.3.1 VESA Grid	12
1.3.2 Ventilation Requirements for Enclosure Locating.....	12
1.4 Mounting in Portrait Position	13
1.5 LCD Display Overview	14
1.5.1 Input/Output Terminals	14
1.5.2 IR and Ambient Light Sensor Ass’y	15
1.6 Remote Control	16
1.6.1 General Functions	16
1.6.2 Inserting the Batteries in the Remote Control	17
1.6.3 Handling the Remote Control	17
1.6.4 Operating Range of the Remote Control.....	17
CHAPTER 2: MAKING CONNECTIONS.....	18
2.1 Connecting the Power	18
2.2 Connecting a Computer	19
2.2.1 Using D-SUB Input	19
2.2.2 Using HDMI Input	19
2.2.3 Using RS232 Input	20
2.2.4 Using DP Input	20
2.3 Connecting External Equipment (Video Player)	21
2.4 Connecting Audio Equipment.....	21

TABLE OF CONTENTS

CHAPTER 3: USING THE LCD DISPLAY	22
3.1 Turning on the Power	22
3.2 Selecting the Input Source Signal	22
3.3 Adjusting the Volume	23
CHAPTER 4: ON SCREEN DISPLAY MENU	24
4.1 Using the OSD Menu	24
4.2 OSD Menu Tree	25
CHAPTER 5: APPENDIX	27
5.1 Warning Messages	27
5.2 Supported Resolution	27
5.3 Cleaning	29
5.4 Troubleshooting	30
5.5 Transporting the LCD Display	31
CHAPTER 6: SPECIFICATIONS	32
6.1 Display Specifications	32
6.2 Display Dimensions	33

SAFETY INFORMATION

CE Declaration of Conformity

This device complies with the requirements set out in the Council Directive on the Approximation of the Laws of the Member States relating to Electromagnetic Compatibility (2014/30/EU), Low-voltage Directive (2014/35/EU), RoHS directive (2011/65/EU).

This product has been tested and found to comply with the harmonized standards for Information Technology Equipment, these harmonized standards published under Directives of Official Journal of the European Union.

Polish Center for Testing and Certification Notice

The equipment should draw power from a socket with an attached protection circuit (a three-prong socket). All equipment that works together (computer, display, printer, and so on) should have the same power supply source.

The phasing conductor of the room's electrical installation should have a reserve short-circuit protection device in the form of a fuse with a nominal value no larger than 16 amperes (A).

To completely switch off the equipment, the power supply cable must be removed from the power supply socket, which should be located near the equipment and easily accessible.

A protection mark "B" confirms that the equipment is in compliance with the protection usage requirements of standards PN-93/T-42107 and PN-89/E-06251.

Wymagania Polskiego Centrum Badań i Certyfikacji

Urządzenie powinno być zasilane z gniazda z przyłączonym obwodem ochronnym (gniazdo z kolkiem). Współpracujące ze sobą urządzenia (komputer, monitor, drukarka) powinny być zasilane z tego samego źródła.

Instalacja elektryczna pomieszczenia powinna zawierać w przewodzie fazowym rezerwową ochronę przed zwarciami, w postaci bezpiecznika o wartości znamionowej nie większej niż 16A (amperów).

W celu całkowitego wyłączenia urządzenia z sieci zasilania, należy wyjąć wtyczkę kabla zasilającego z gniazdką, które powinno znajdować się w pobliżu urządzenia i być łatwo dostępne.

Znak bezpieczeństwa "B" potwierdza zgodność urządzenia z wymaganiami bezpieczeństwa użytkowania zawartymi w PN-93/T-42107 i PN-89/E-06251.

Pozostałe instrukcje bezpieczeństwa

- Nie należy używać wtyczek adapterowych lub usuwać kolka obwodu ochronnego z wtyczki. Jeżeli konieczne jest użycie przedłużacza to należy użyć przedłużacza 3-żyłowego z prawidłowo połączonym przewodem ochronnym.
- System komputerowy należy zabezpieczyć przed nagłymi, chwilowymi wzrostami lub spadkami napięcia, używając eliminatora przepięć, urządzenia dopasowującego lub bezzakłóceniewego źródła zasilania.
- Należy upewnić się, aby nic nie leżało na kablach systemu komputerowego, oraz aby kable nie były umieszczone w miejscu, gdzie można byłoby na nie nadeptywać lub potykać się o nie.
- Nie należy rozlewać napojów ani innych płynów na system komputerowy.
- Nie należy wpychać żadnych przedmiotów do otworów systemu komputerowego, gdyż może to spowodować pożar lub porażenie prądem, poprzez zwarcie elementów wewnętrznych.
- System komputerowy powinien znajdować się z dala od grzejników i źródeł ciepła. Ponadto, nie należy blokować otworów wentylacyjnych. Należy unikać kładzenia luźnych papierów pod komputer oraz umieszczania komputera w ciasnym miejscu bez możliwości cyrkulacji powietrza wokół niego.

SAFETY INFORMATION

Electric, Magnetic and Electromagnetic Fields (“EMF”)

- We manufacture and sell many products targeted at consumers, which, like any electronic apparatus, in general have the ability to emit and receive electromagnetic signals.
- One of our leading Business Principles is to take all necessary health and safety measures for our products, to comply with all applicable legal requirements and to stay well within the EMF standards applicable at the time of producing the products.
- We are committed to develop, produce and market products that cause no adverse health effects.
- We confirm that if its products are handled properly for their intended use, they are safe to use according to scientific evidence available today.
- We play an active role in the development of international EMF and safety standards, enabling us to anticipate further developments in standardization for early integration in its products.

Information for U.K. Only

WARNING - THIS APPLIANCE MUST BE EARTHED.

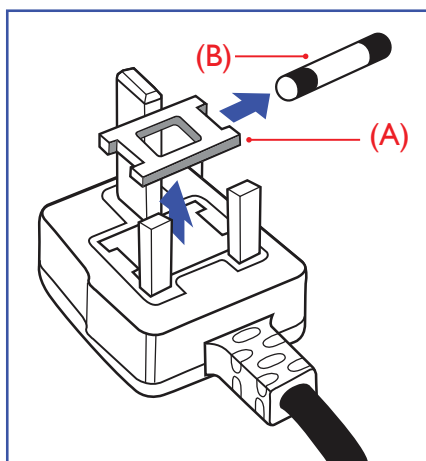

Important:

This apparatus is supplied with an approved moulded 13A plug. To change a fuse in this type of plug proceed as follows:

- 1 Remove fuse cover and fuse.
- 2 Fit new fuse which should be a BS 1362 5A,A.S.T.A. or BSI approved type.
- 3 Refit the fuse cover.



Note:

The severed plug must be destroyed to avoid a possible shock hazard should it be inserted into a 13A socket elsewhere.

SAFETY INFORMATION

If the fitted plug is not suitable for your socket outlets, it should be cut off and an appropriate 3-pin plug fitted in its place.

If the mains plug contains a fuse, this should have a value of 5A. If a plug without a fuse is used, the fuse at the distribution board should not be greater than 5A.

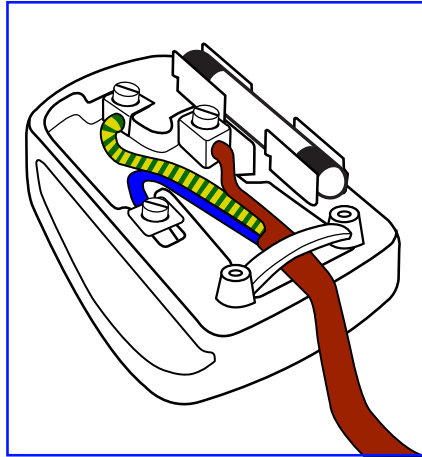

How to connect a plug

The wires in the mains lead are coloured in accordance with the following code:

BLUE - "NEUTRAL" ("N")

BROWN - "LIVE" ("L")

GREEN & YELLOW - "EARTH" ("E")

- The GREEN & YELLOW wire must be connected to the terminal in the plug which is marked with the letter "E" or by the Earth symbol or coloured GREEN or GREEN & YELLOW.
- The BLUE wire must be connected to the terminal which is marked with the letter "N" or coloured BLACK.
- The BROWN wire must be connected to the terminal which marked with the letter "L" or coloured RED.

Before replacing the plug cover, make certain that the cord grip is clamped over the sheath of the lead - not simply over the three wires.

SAFETY INFORMATION

North Europe (Nordic Countries) Information

Placering/Ventilation

WARNING: FÖRSÄKRA DIG OM ATT HUVUDBRYTARE OCH UTTAG ÄR LÄTÅTKOMLIGA, NÄR DU STÄLLER DIN UTRUSTNING PÅPLATS.

Placering/Ventilation

ADVARSEL: SØRG VED PLACERINGEN FOR, AT NETLEDNINGENS STIK OG STIKKONTAKT ER NEMT TILGÆNGELIGE.

Paikka/Ilmankierto

VAROITUS: SIJOITA LAITE SITEN, ETTÄ VERKKOJOHTO VOIDAAN TARVITTAESSA HELPOSTI IRROTTAA PISTORASIESTA.

Plassering/Ventilasjon

ADVARSEL: NÅR DETTE UTSTYRET PLASSERES, MÅ DU PASSE PÅ AT KONTAKTENE FOR STØMTILFØRSEL ER LETTE Å NÅ.

End-of-Life Disposal

Your new Public Information Display contains materials that can be recycled and reused. Specialized companies can recycle your product to increase the amount of reusable materials and to minimize the amount to be disposed of.

Please find out about the local regulations on how to dispose of your old display from your local dealer.

(For customers in Canada and U.S.A.)

This product may contain lead and/or mercury. Dispose of in accordance to local-state and federal regulations. For additional information on recycling contact www.eia.org (Consumer Education Initiative).

Waste Electrical and Electronic Equipment-WEEE

Attention users in European Union private households



Disposal of Waste Equipment by Users in Private Household in the European Union.

This symbol on the product or on its packaging indicates that this product must not be disposed of with your other household waste. Instead, it is your responsibility to dispose of your waste equipment by handing it over to a designated collection point for the recycling of waste electrical and electronic equipment. The separate collection and recycling of your waste equipment at the time of disposal will help to conserve natural resources and ensure that it is recycled in a manner that protects human health and the environment. For more information about where you can drop off your waste equipment for recycling, please contact your local city office, your household waste disposal service or the shop where you purchased the product.

For Private Households in the European Union. To help conserve natural resources and ensure the product is recycled in a manner that protects human health and the environment, we would like to bring your attention to

SAFETY INFORMATION

the following:

- The crossed-out dustbin on the device or outer packaging indicates the product is compliant with European WEEE (Waste Electrical and Electronic Equipment) Directive
- Always dispose of the old devices separately from household waste
- Batteries should be removed beforehand and disposed separately to the right collection system
- You are responsible with regard to the deletion of personal data on old devices before disposal
- Private households can hand in their old devices free of charge
- For more information about where you can drop off your waste equipment for recycling, please contact your local city office, your household waste disposal service or the shop where you purchased the product

Attention users in United States:

Please dispose of according to all Local, State and Federal Laws. For the disposal or recycling information, contact: www.mygreenelectronics.com or www.eiae.org.

End of Life Directives-Recycling



Your new Public Information Display contains several materials that can be recycled for new users.

Please dispose of according to all Local, State, and Federal laws.

Restriction on Hazardous Substances statement (India)

This product complies with the "India E-waste Rule 2011" and prohibits use of lead, mercury, hexavalent chromium, polybrominated biphenyls or polybrominated diphenyl ethers in concentrations exceeding 0.1 weight % and 0.01 weight % for cadmium, except for the exemptions set in Schedule 2 of the Rule.

E-Waste Declaration for India

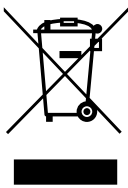

This symbol on the product or on its packaging indicates that this product must not be disposed of with your other household waste. Instead it is your responsibility to dispose of your waste equipment by handing it over to a designated collection point for the recycling of waste electrical and electronic equipment. The separate collection and recycling of your waste equipment at the time of disposal will help to conserve natural resources and ensure that it is recycled in a manner that protects human health and the environment.

Batteries



For EU: The crossed-out wheeled bin implies that used batteries should not be put to the general household waste! There is a separate collection system for used batteries, to allow proper treatment and recycling in accordance with legislation.

Please contact your local authority for details on the collection and recycling schemes.

For Switzerland: The used battery is to be returned to the selling point.

For other non-EU countries: Please contact your local authority for correct method of disposal of the used battery.

SAFETY INFORMATION

According to EU directive 2006/66/EC, the battery can't be disposed improperly. The battery shall be separated to collect by local service.

Turkey RoHS

Türkiye Cumhuriyeti: EEE Yönetmeliğine Uygundur.

Ukraine RoHS

Обладнання відповідає вимогам Технічного регламенту щодо обмеження використання деяких небезпечних речовин в електричному та електронному обладнанні, затвердженого постановою Кабінету Міністрів України від 3 грудня 2008 № 1057.

PRECAUTIONS

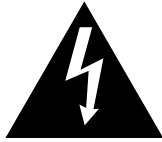

Symbols used in this manual

	This icon indicates the existence of a potential hazard that could result in personal injury or damage to the product.
	This icon indicates important operating and servicing information.

Notice

- Read this User Manual carefully before using the LCD display and keep it for future reference.
- The product specifications and other information provided in this User Manual are for reference only. All information is subject to change without notice. Updated content can be downloaded from our web site at www.agneovo.com.
- To protect your rights as a consumer, do not remove any stickers from the LCD display. Doing so may affect the determination of the warranty period.

Cautions When Setting Up

- Do not place the LCD display near heat sources, such as a heater, exhaust vent, or in direct sunlight.
- Do not cover or block the ventilation holes in the housing.
- Place the LCD display on a stable area. Do not place the LCD display where it may subject to vibration or shock.
- Place the LCD display in a well-ventilated area.
- Do not place the LCD display outdoors.
- To avoid the risk of shock or permanent damage to the set, do not expose the display to dust, rain, water or an excessively moist environment.
- Do not spill liquid or insert sharp objects into the LCD display through the ventilation holes. Doing so may cause accidental fire, electric shock or damage the LCD display.

PRECAUTIONS

Cautions When Using

- Use only the power cord supplied with the LCD display.
- The power outlet should be installed near the LCD display and be easily accessible.
- If an extension cord is used with the LCD display, ensure that the total current consumption plugged into the power outlet does not exceed the ampere rating.
- Do not allow anything to rest on the power cord. Do not place the LCD display where the power cord may be stepped on.
- If the LCD display will not be used for an indefinite period of time, unplug the power cord from the power outlet.
- To disconnect the power cord, grasp and pull by the plug head. Do not tug on the cord; doing so may cause fire or electric shock.
- Do not unplug or touch the power cord with wet hands.
- When turning off the display by detaching the power cord, wait 6 seconds before re-attaching the power cord for normal operation.
- Do not knock or drop the display during operation or transportation.

Cleaning and Maintenance

- To protect your display from possible damage, do not put excessive pressure on the LCD panel. When moving your display, grasp the frame to lift; do not lift the display by placing your hand or fingers on the LCD panel.
- Unplug the display if you need to clean it with a slightly damp cloth. The screen may be wiped with a dry cloth when the power is off. However, never use organic solvent, such as, alcohol, or ammonia-based liquids to clean your display.
- If your display becomes wet, wipe it with dry cloth as soon as possible.
- If a foreign substance or water gets in your display, turn the power off immediately and disconnect the power cord. Then remove the foreign substance or water, and send the unit to the maintenance center.
- In order to maintain the best performance of your display and ensure a longer lifetime, we strongly recommend using the display in a location that falls within the following temperature and humidity ranges.
 - ◆ Temperature: 0-40°C (32-104°F)
 - ◆ Humidity: 20-80% RH



Warning:



Unplug the power cord from the power outlet and refer to qualified service

personnel under the following conditions:

- ◆ When the power cord is damaged.
- ◆ If the LCD display has been dropped or the housing has been damaged.
- ◆ If the LCD display emits smoke or a distinct odor.

PRECAUTIONS

Notice for the LCD Display

- In order to maintain the stable luminous performance, it is recommended to use low brightness setting.
- Due to the lifespan of the lamp, it is normal that the brightness quality of the LCD display may decrease with time.
- When static images are displayed for long periods of time, the image may cause an imprint on the LCD display. This is called image retention or burn-in.
 - ◆ To prevent image retention, do any of the following:
 - Set the LCD display to turn off after a few minutes of being idle.
 - Use a screen saver that has moving graphics or a blank white image.
 - Execute the Anti-Burn-in function of the LCD display. See “Anti-Burn-in” on page 25.
 - Switch desktop backgrounds regularly.
 - Adjust the LCD display to low brightness settings.
 - Turn off the LCD display when the system is not in use.
 - ◆ Things to do when the LCD display shows image retention:
 - Turn off the LCD display for extended periods of time. It can be several hours or several days.
 - Use a screen saver and run it for extended periods of time.
 - Use a black and white image and run it for extended periods of time.
- There are millions of micro transistors inside the LCD display. It is normal for a few transistors to be damaged and to produce spots. This is acceptable and is not considered a failure.
- **IMPORTANT:** Always activate a moving screen saver program when you leave your display unattended. Always activate a periodic screen refresh application if the unit will display unchanging static content. Uninterrupted display of still or static images over an extended period may cause “burn in”, also known as “after-imaging” or “ghost imaging”, on your screen. This is a well-known phenomenon in LCD panel technology. In most cases, the “burned in” or “after-imaging” or “ghost imaging” will disappear gradually over a period of time after the power has been switched off.
- **WARNING:** Severe “burn-in” or “after-image” or “ghost image” symptoms will not disappear and cannot be repaired. This is also not covered under the terms of your warranty.

CHAPTER 1: PRODUCT DESCRIPTION

1.1 Package Contents

When unpacking, check if the following items are included in the package. If any of them is missing or damaged, contact your dealer.

LCD Display



Quick Start Guide



Remote Control



Power Cord (for EU except UK)

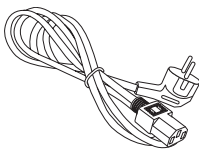

Power Cord (for UK)

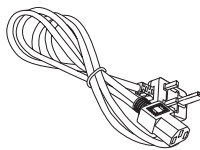

IR and Ambient Light Sensor Ass'y

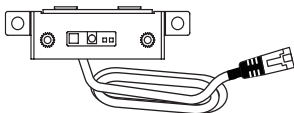

Battery AAA x2



Note:

- ◆ Remote control is shipped with the supplied AAA batteries.
- ◆ For all other regions, apply a power cord that conforms to the AC voltage of the power socket and has been approved by and complies with the safety regulations of the particular country.
- ◆ You might like to save the package box and packing material for shipping the display.

Note:

- ◆ The pictures are for reference only. Actual items may vary upon shipment.

PRODUCT DESCRIPTION

1.2 Moving the Display

1.2.1 Carrying the Display

When carrying the display, always hold it with two people using both hands and the screen facing forward.

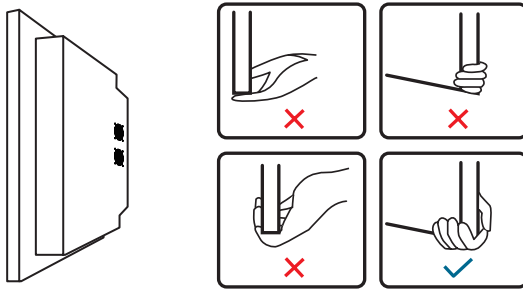

1.2.2 Setting Down the Display

When setting the display down, place the screen face down on a flat and stable surface covered by a protective sheet and a table cushion as shown in the illustration provided.

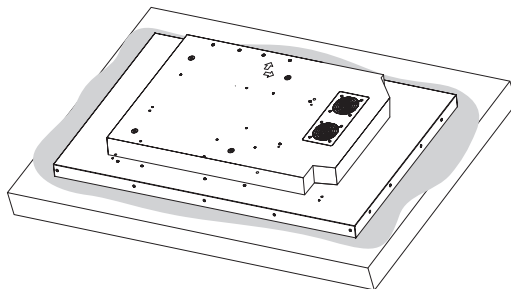

1.2.3 Placing the Display

When placing the display, keep the display upright. Never tilt the display towards the left, right, or balanced on a single corner of the frame.

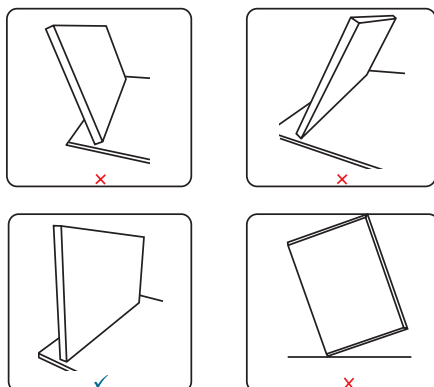

Warning:

- ◆ Do not press too hard on the LCD panel or edge of the frame, as this may cause the device to malfunction.
- ◆ During unpacking, make sure to hold the carrying handles to remove the device from its packaging.



Caution:

- ◆ Avoid applying force or using sharp objects on the LCD panel at all times.



Caution:

- ◆ Never press or place anything on the back cover. This may damage the internal parts of the display.

PRODUCT DESCRIPTION

1.3 Wall Mounting Installation

To mount this display to a wall, you will have to obtain a standard wall-mounting kit (commercially available).

To wall-mount the LCD display, screw the mounting bracket to the VESA holes at the rear of the LCD display.

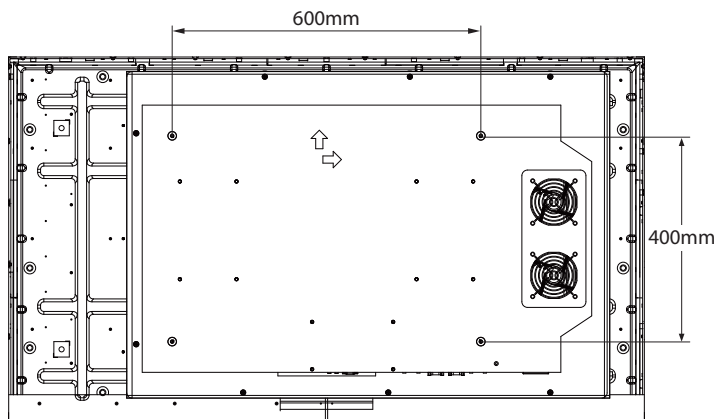

1.3.1 VESA Grid

Model Name	VESA Grid
PO-5502	600(H) x 400(V) mm

⚠ Caution:

To prevent the display from falling:

- ◆ For wall or ceiling installation, we recommend installing the display with metal brackets which are commercially available.
- ◆ AG Neovo also provides a great variety of wall mounts for different installation uses. For more information, please visit: www.agneovo.com/accessories
- ◆ To lessen the probability of injury and damage resulting from fall of the display in case of earthquake or other natural disaster, be sure to consult the bracket manufacturer for installation location.

1.3.2 Ventilation Requirements for Enclosure Locating

To allow heat to disperse, leave space between surrounding objects as shown in the diagram below.

Note:

- ◆ Avoid the wall-mounting kit to block the ventilation holes on the back of the display.
- ◆ Make sure the distance between the LCD display fans and the wall is at least 4~5 cm.
- ◆ Secure the LCD display (Unit weight= 23.5 kg/ 51.8lbs.) on a solid wall strong enough to bear its weight.
- ◆ Lay a protective sheet on a table, which was wrapped around the display when it was packaged, beneath the screen surface so as not to scratch the screen face.
- ◆ For the wall-mounting kit, use M6 mounting screws (having a length 18 mm longer than the thickness of the mounting bracket) and tighten them securely.

PRODUCT DESCRIPTION

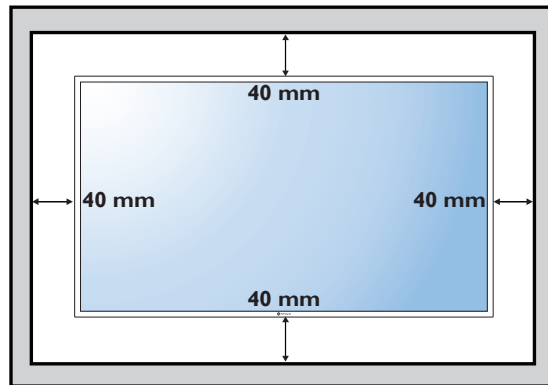

1.4 Mounting in Portrait Position

This display can be installed in portrait position.

Rotate 90 degrees counter-clockwise such that one of the arrows on the rear of the LCD display is pointing up and the other to the left side (as illustrated below).

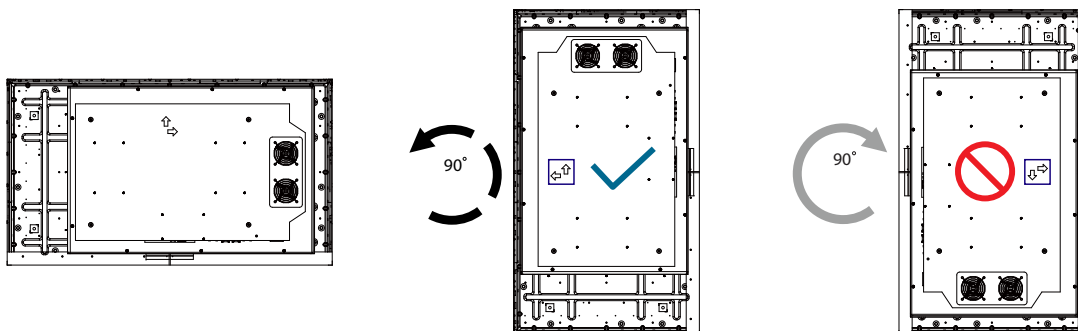

PRODUCT DESCRIPTION

1.5 LCD Display Overview

1.5.1 Input/Output Terminals

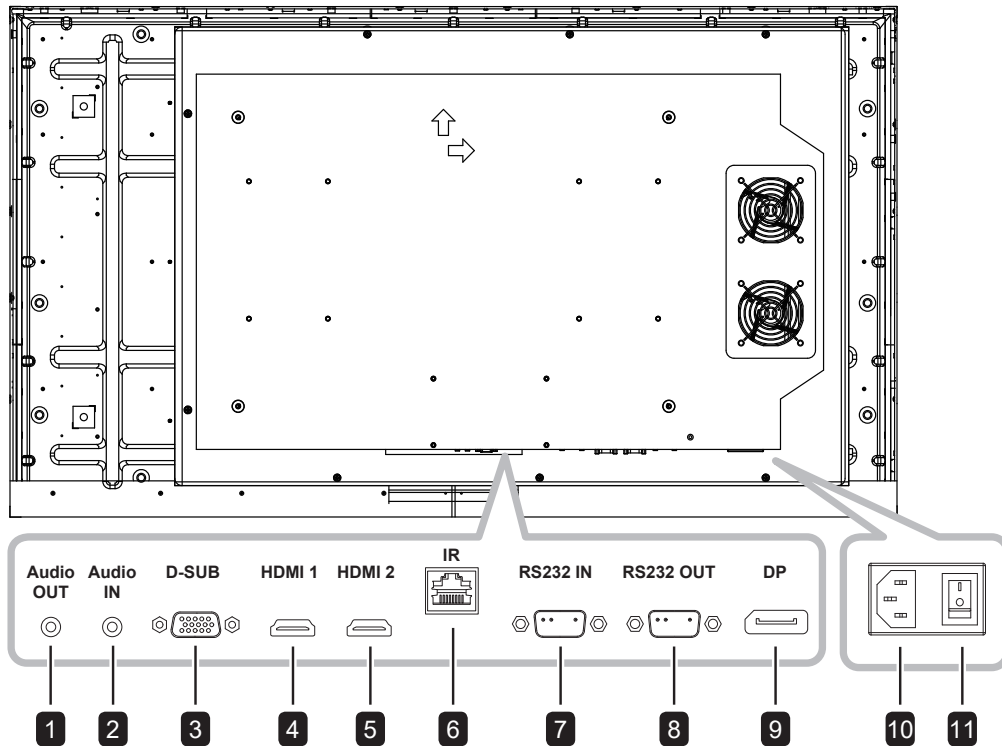

1 AUDIO OUT

Connects with external speakers or audio amplifier to output the audio that is supplied by the video source.

2 AUDIO IN

Connects with the audio out connector of a video source such as a computer, video player when the display is connected to the source via the D-SUB.

3 D-SUB

Connects with the analog video output (VGA) of a computer.

4 5 HDMI 1/ HDMI 2

Connects with devices supporting audio/video data using the HDMI interface.

6 IR

It can only connect with the accessory "IR and ambient light sensor ass'y."

7 RS232 IN

Connect RS232 input from external equipment.

8 RS232 OUT

Connect RS232 output to additional displays.

9 DisplayPort (DP)

Connects with devices transmitting audio/video using the Display Port interface.

10 AC-IN

Connects with the supplied power cord

11 Main Power switch

Switches the main power on or off.

PRODUCT DESCRIPTION

1.5.2 IR and Ambient Light Sensor Ass'y

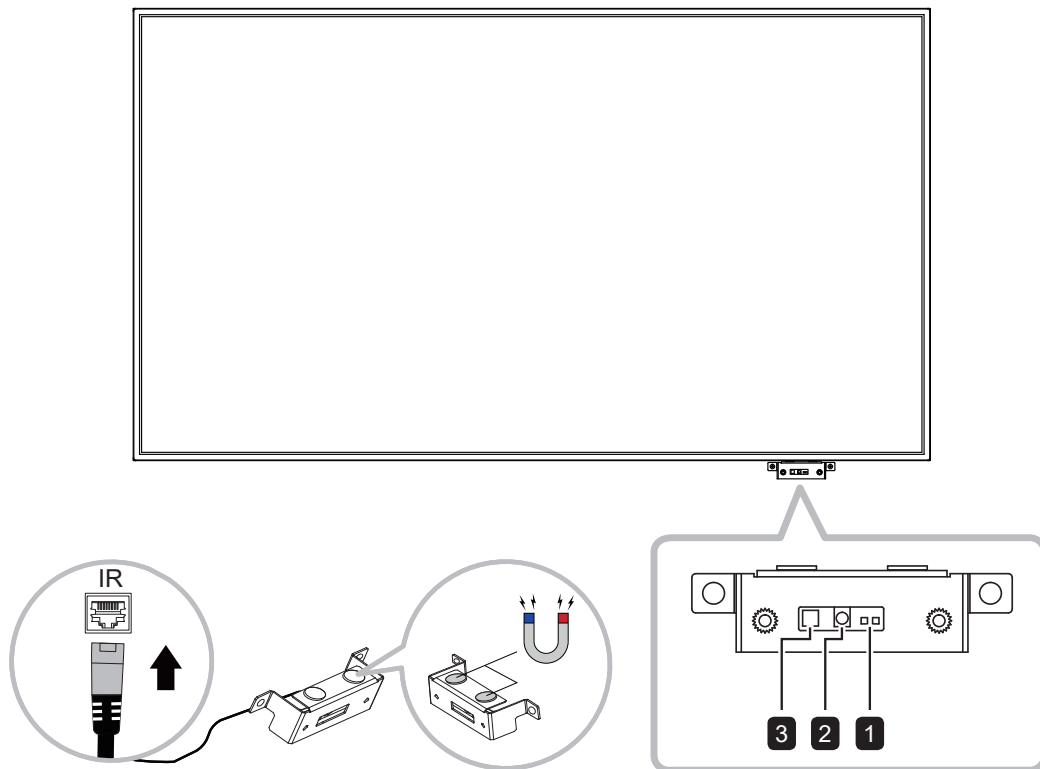

1 IR Sensor Indicator

Displays the status of the IR sensor.

- Green: The display's power is on.
- Red: The display is in power saving mode.
- Off: The display's power is off.

2 IR Sensor

The IR sensor board needs to be connected to the IR hole first. Receives the signal from the remote control.

3 Light Sensor

Receives ambient light and enable automatic backlight adjustment.

Note:

- ◆ Please make sure the light sensor is not covered when enabling Auto Dimming function.
- ◆ The IR and ambient light sensor ass'y can be magnetised and easily moved to the rear of the displays or the iron cases to suit different outdoor environments.

PRODUCT DESCRIPTION

1.6 Remote Control

1.6.1 General Functions

1 [POWER] POWER

Turns the display on or off.

Note:

- ◆ If the power indicator is not lit then the controls will not function.

2 [MUTE] MUTE

Press the MUTE button to mute the audio.

3 MENU

Displays the OSD menu. Please refer to page 24.

4 [LEFT] [RIGHT] [UP] [DOWN] NAVIGATION buttons

Navigates through menus, selects items, and adjusts values.

5 EXIT

Exits the current menu.

6 ENTER

Selects items or accepts the settings made in the OSD menu.

7 SOURCE

Switches the video input source. Use the [UP] [DOWN] buttons to select [D-SUB], [HDMI1], [HDMI2], or [DP] and press the **ENTER** button to confirm the selection.

8 [VOL -] [VOL +] VOL

- Press [VOL -] to decrease volume.
- Press [VOL +] to increase volume.

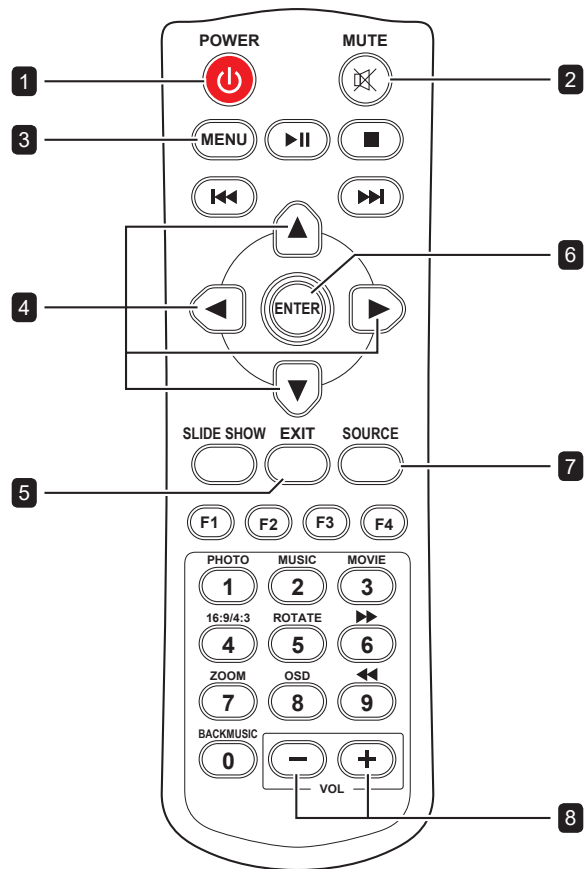

Note:

- ◆ The unlabeled buttons do not support functions.

PRODUCT DESCRIPTION

1.6.2 Inserting the Batteries in the Remote Control

The remote control is powered by two 1.5V AAA batteries.

To install or replace batteries:

- 1 Open the remote control battery compartment cover.
- 2 Align the batteries according to the (+) and (-) indications inside the battery compartment.
- 3 Replace the cover.

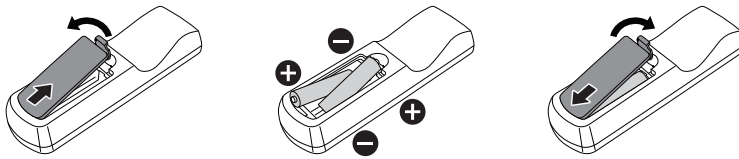

1.6.3 Handling the Remote Control

- Do not subject to strong shock.
- Do not allow water or other liquid to splash the remote control. If the remote control gets wet, wipe it dry immediately.
- Avoid exposure to heat and steam.
- Other than to install the batteries, do not open the remote control.

1.6.4 Operating Range of the Remote Control

Point the top of the remote control toward the display's remote control sensor when pressing a button.

Point the remote control toward the display's IR sensor within a distance of less than 3 m / 9.84 ft, and a horizontal and vertical angle of less than 30 degrees, when operating the remote control.

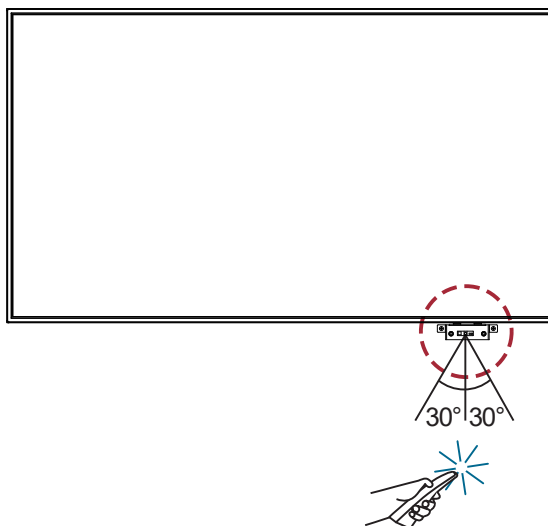

Caution:

The incorrect use of batteries can result in leaks or bursting. Be sure to follow these instructions:

- ◆ Place “AAA” batteries matching the (+) and (-) signs on each battery to the (+) and (-) signs of the battery compartment.
- ◆ Do not mix battery types.
- ◆ Do not combine new batteries with used ones. It causes shorter life or leakage of batteries.
- ◆ Remove the dead batteries immediately to prevent them from liquid leaking in the battery compartment. Don't touch exposed battery acid, as it can damage your skin.

Note:

- ◆ If you do not intend to use the remote control for a long period, remove the batteries.
- ◆ The remote control may not function properly when the remote control sensor on this display is under direct sunlight or strong illumination, or when there is an obstacle in the path of signal transmission.

CHAPTER 2: MAKING CONNECTIONS

2.1 Connecting the Power

- 1 Connect one end of the power cord to the AC IN connector at the side of the LCD display.
- 2 Connect the other end of the power cord to a power outlet or a power supply.
- 3 Set the **Main Power** switch to ON.

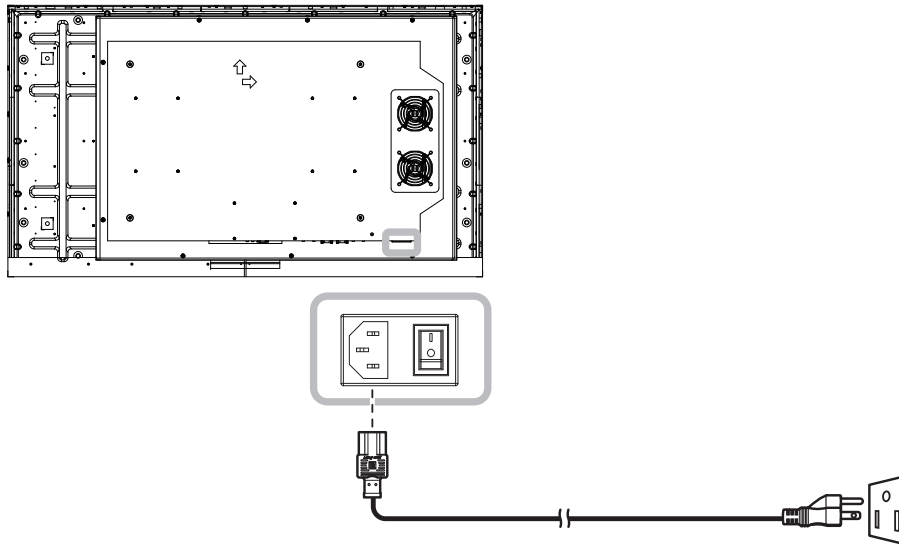

Caution:

- ◆ Make sure that the LCD display is not connected to the power outlet before making any connections. Connecting cables while the power is ON may cause electric shock or personal injury.
- ◆ When unplugging the power cord, hold the power cord by the plug head. Never pull by the cord.
- ◆ Loose connections may cause noise. Do not plug and unplug the power cord repeatedly in a short period of time.
- ◆ When disconnecting the AC power cord, be sure to first disconnect the plug from the outlet socket.

Note:

- ◆ The supplied power cord varies depending on the country where you purchased this LCD display. For all cases, use a power cord that matches the AC voltage of the power outlet and has been approved by and complies with the safety standard of your country.

MAKING CONNECTIONS

2.2 Connecting a Computer

2.2.1 Using D-SUB Input

- 1 Connect one end of a D-SUB cable to the D-SUB connector of the LCD display and the other end of a D-SUB cable to the VGA OUT (D-SUB) connector of the computer.
- 2 For audio input, connect one end of an audio cable to the AUDIO IN connector of the LCD display and the other end of an audio cable to the AUDIO OUT connector of the computer.
- 3 Press the **SOURCE** button on the remote control to select the video input source (D-SUB). Once selected, the audio input setting will automatically switch to the correct audio source for the video connection.

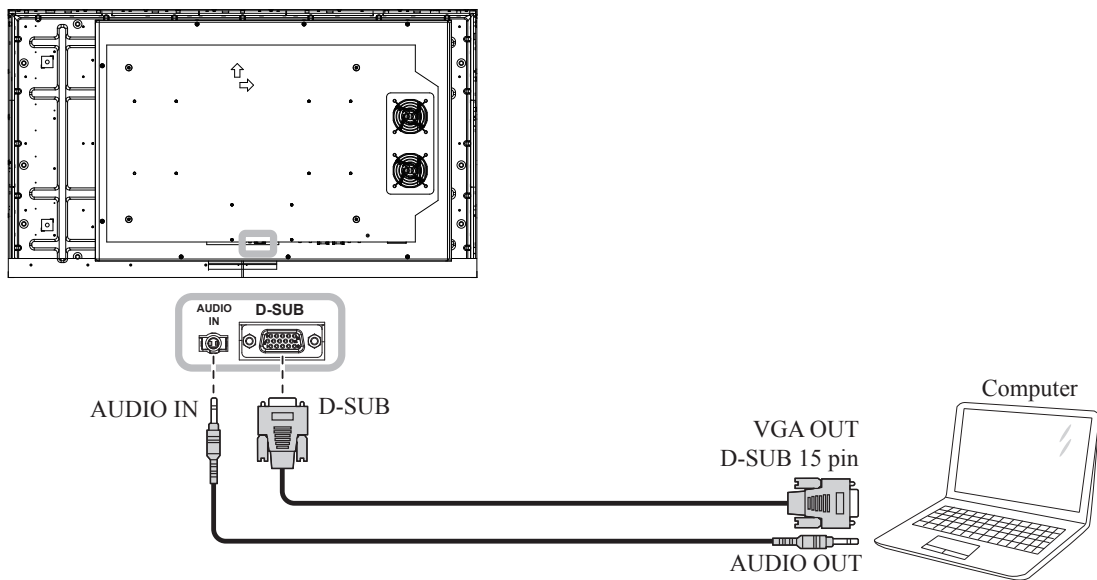

2.2.2 Using HDMI Input

Connect one end of an HDMI cable to the HDMI connector of the LCD display and the other end of an HDMI cable to the HDMI OUT connector of the computer.

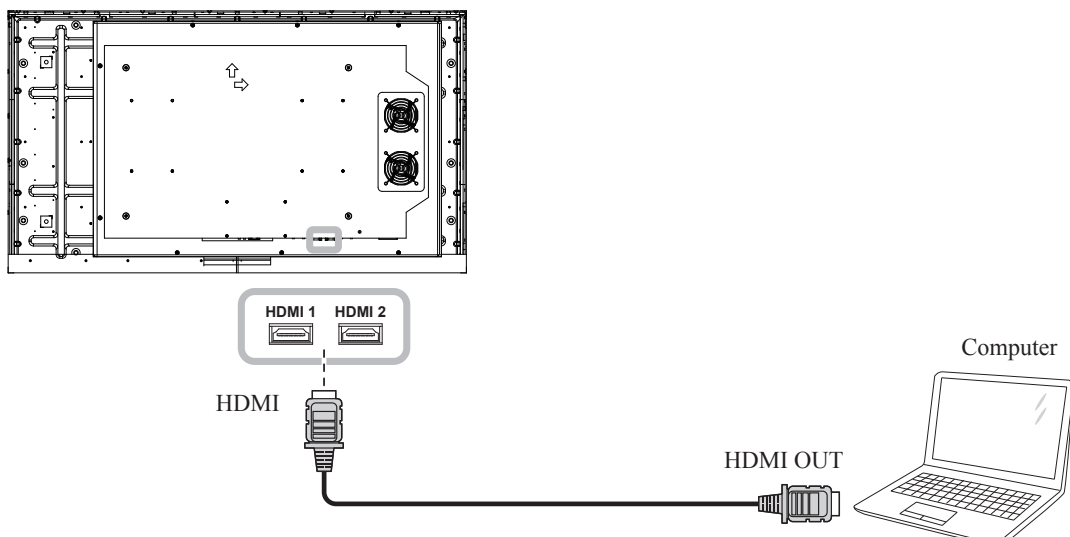

MAKING CONNECTIONS

2.2.3 Using RS232 Cables

Connect one end of a RS232 cable to the RS232 IN connector of the LCD display and the other end to the RS232 connector of the computer.

To create a daisy-chain configuration for applications, connect one end of a RS232 cable to the RS232 OUT connector of the Display 1 and the other end to the RS232 IN connector of the Display 2

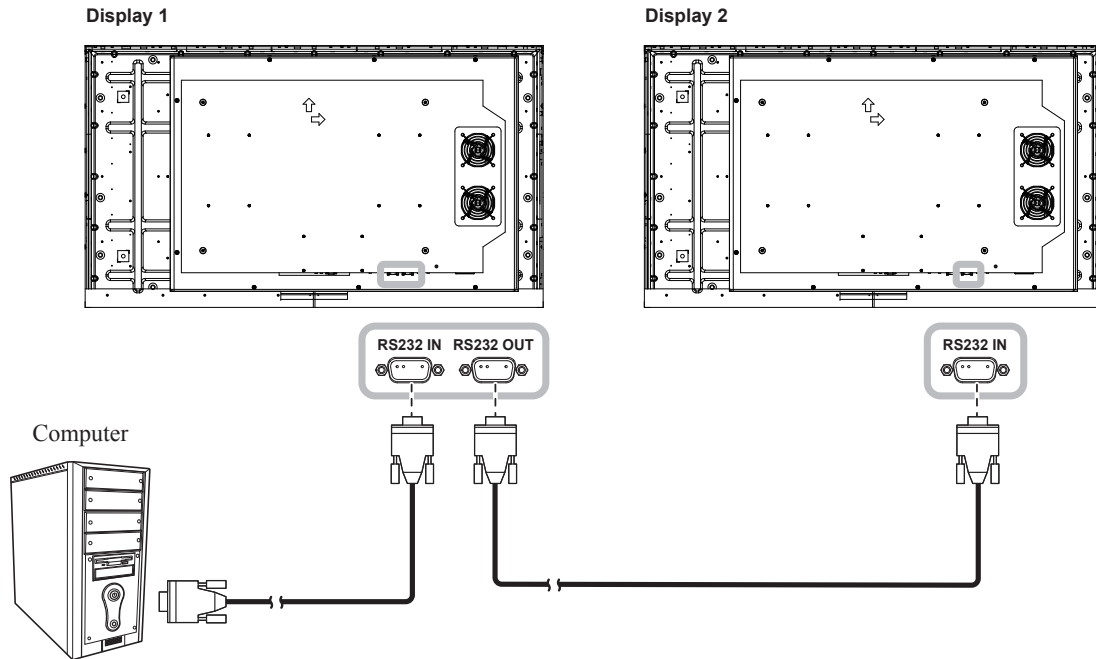

2.2.4 Using DP Input

- 1 Connect one end of a DisplayPort cable to the DP connector of the LCD display and the other end of a DisplayPort cable to the DisplayPort connector of the computer.
- 2 Press the **SOURCE** button on the remote control to select the video input source (DP).

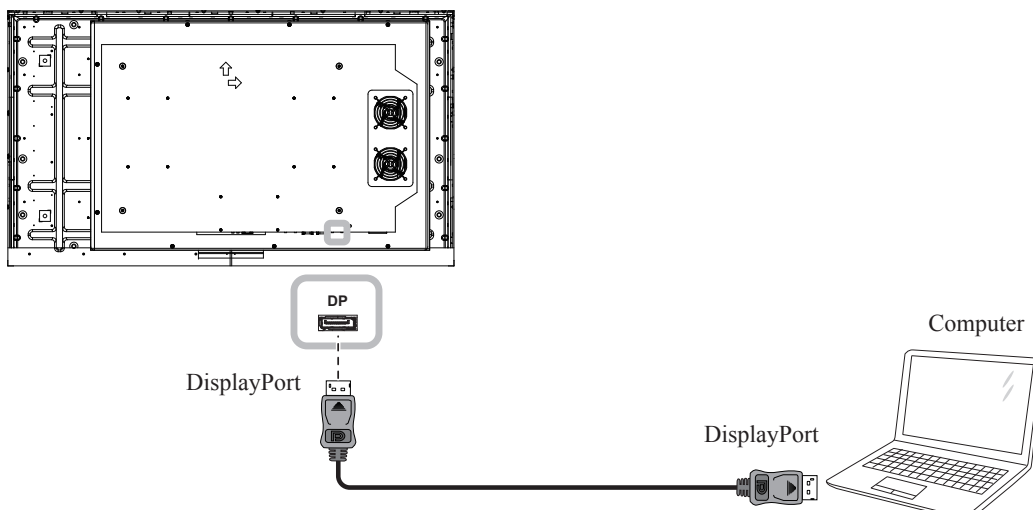

MAKING CONNECTIONS

2.3 Connecting External Equipment (Video Player)

Connect one end of an HDMI cable to the HDMI connector of the LCD display and the other end of an HDMI cable to the HDMI OUT connector of the video player.

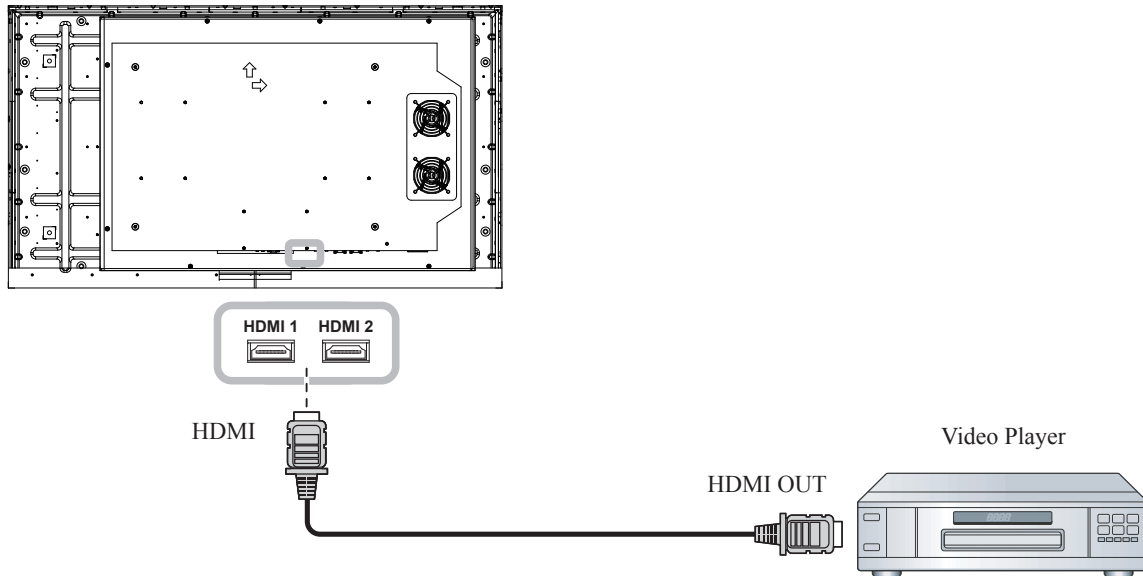

2.4 Connecting Audio Equipment

Connect one end of an audio cable to the AUDIO OUT connector of the LCD display and the other end of an audio cable to the AUDIO IN connector of the audio device.

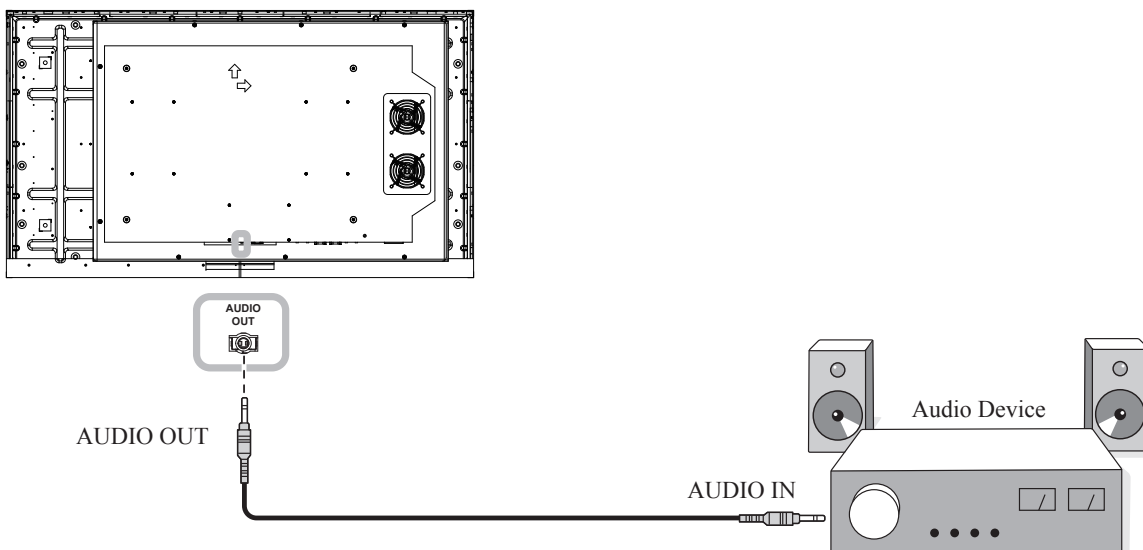

CHAPTER 3: USING THE LCD DISPLAY

3.1 Turning on the Power

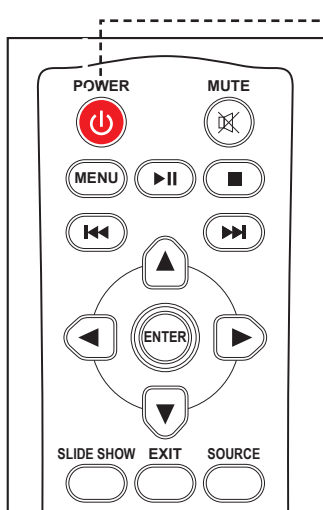

- 1 Plug the power cord to a power outlet or power supply.
- 2 Set the **Main Power** switch to ON.
- 3 Press the  button to turn the LCD display on.



When the LCD display is turned on, press the  button to turn off the LCD display.

Note:

- ◆ The LCD display still consumes power as long as the power cord is connected to the power outlet. Disconnect the power cord to completely cut off power.

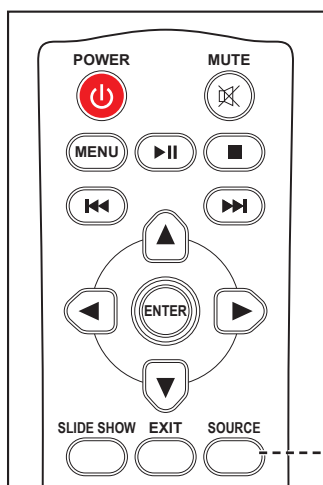
3.2 Selecting the Input Source Signal



- 1 Press the **SOURCE** button.
- 2 Press the  or  button to choose the input source, then press the **ENTER** button.

Note:

- ◆ If no input source is detected, after pressing the **SOURCE** button, a menu with available input sources will be displayed on the screen.

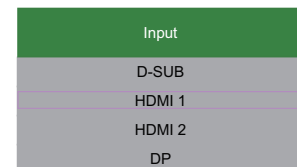

- ◆ If the selected input source signal is not connected to the LCD display or is turned off, the no input message is displayed on the screen.

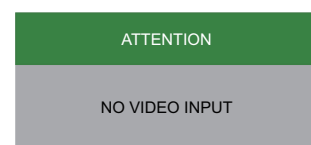

USING THE LCD DISPLAY

3.3 Adjusting the Volume

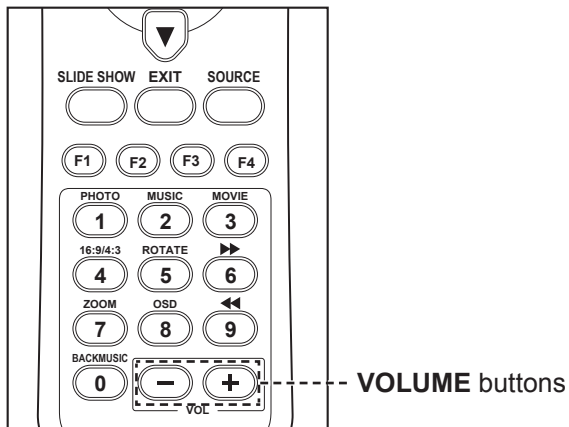

Press the **—** or **+** button to adjust the volume.

Note:

- ◆ After pressing the **—** or **+** button, the volume adjustment bar is displayed on the screen automatically.

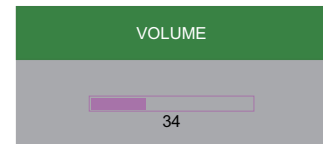

- ◆ Press the **MUTE** button to mute the audio.

CHAPTER 4: ON SCREEN DISPLAY MENU

4.1 Using the OSD Menu

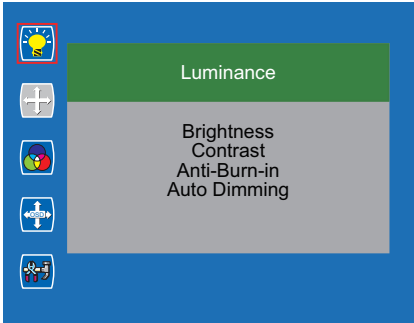
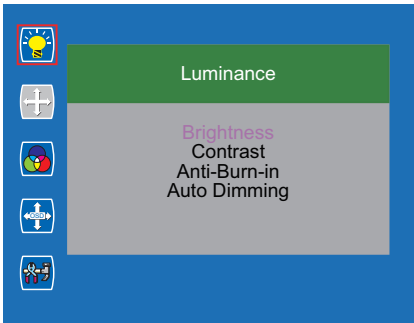
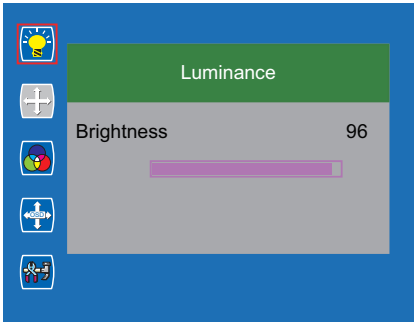



#	Menu Navigation	Remote Control
1	<p>Display the main menu screen.</p> 	<p>Press the MENU button.</p>
2	<p>Enter the submenu.</p>  <p>The item inside the orange rectangle indicates the active submenu item.</p>	<ol style="list-style-type: none"> 1 Press the ▲ or ▼ button to select the main menu item. 2 Press the ENTER button to enter the submenu.
3	<p>Adjust the settings.</p> <p>For example:</p> 	<ol style="list-style-type: none"> 1 Press the ▲ or ▼ button to select the submenu item. 2 Press the ENTER button to enter the adjustment mode. 3 Press the ▲ or ▼ button to adjust the settings.
4	<p>Exit the submenu.</p>	<p>Press the EXIT button.</p>
5	<p>Close the OSD window.</p>	<p>Press the EXIT button repeatedly if necessary.</p>

When settings are modified, all changes are saved when the user does the following:

- Proceeds to another menu.
- Exits the OSD menu.
- Waits for the OSD menu to disappear.

ON SCREEN DISPLAY MENU

4.2 OSD Menu Tree

Main Menu	Submenu	Range	Function description	
Luminance 	Brightness	0-100	Adjusts the brightness of the display	
	Contrast	0-100	Adjusts the contrast of the display	
	Anti-Burn-in	Off		Triggers the screen saver function (Off/On). This process will then be activated each time the display is powered on.
		On		
Auto Dimming	Off	On	When this function is enabled, the light sensor will be activated and the display's brightness will be adjusted automatically based on ambient light (Off/On).	
	On			
Picture 	phase	0-100	Adjusts the frequency phase of the display	
	clock	0-100	Adjusts the pixel clock (or dot clock) setting of the display	
	H. Position	0-100	Adjusts the picture along the horizontal axis	
	V. Position	0-100	Adjusts the picture along the vertical axis	
Color 	Color Temperature	6500K	Adjusts the color temperature of the display	
		9300K		
		11500K		
		sRGB		
		User Define		
	Red	0-100	Adjusts the red value of the display (0~100) (Only available for User Define mode)	
	Green	0-100	Adjusts the green value of the display (0~100) (Only available for User Define mode)	
Blue	0-100	Adjusts the blue value of the display (0~100) (Only available for User Define mode)		
OSD Setting 	Horizontal	0-100	Adjusts the position of the OSD menu horizontally	
	Vertical	0-100	Adjusts the position of the OSD menu vertically	
	OSD Time Out	5-60	Changes the OSD menu timer settings (5 ~60) where the number selected for this setting equals the number of seconds the OSD menu is displayed before it automatically closes.	
	OSD Rotation	0-3	Rotates the OSD menu	

ON SCREEN DISPLAY MENU

Main Menu	Submenu	Range	Function description
Setup 	Language	English	Chooses the OSD Menu language
		Français	
		Deutsch	
		Español	
		繁體中文	
		简体中文	
		日本語	
	Input	D-SUB	Selects the signal input for the display
		HDMI1	
		HDMI2	
		DP	
	Display Size	Full Screen	Adjusts the aspect ratio of the display
		Auto	
		4:3	
	Reset	Yes	Resets the display to its factory default settings
		No	
	Power Saving	Off	Configures the display so that it will automatically turn off when no signal is detected (Off / On)
		ON	
Monitor ID	1-100	Sets a unique ID number for the display	
Information	FW Version	Displays the display information	
	Thermal		
	Resolution		

CHAPTER 5: APPENDIX

6.1 Warning Messages

Warning Messages	Cause	Solution
<p style="text-align: center;">ATTENTION</p> <p style="text-align: center;">CANNOT DISPLAY THIS VIDEO</p>	The resolution or the refresh rate of the graphics card of the computer is set too high.	<ul style="list-style-type: none"> • Change the resolution or the refresh rate of the graphics card.
<p style="text-align: center;">ATTENTION</p> <p style="text-align: center;">NO VIDEO INPUT</p>	The LCD display cannot detect the input source signal.	<ul style="list-style-type: none"> • Check if the input source is turned on. • Check if the signal cable is properly connected. • Check if any pin inside the cable connector is twisted or broken.

6.2 Supported Resolution

VGA Resolution:

	Resolution	Refresh Rate (Hz)
PC Timing	640x480	60
	800x600	60
	1024x768	60
	1280x768	60
	1920x1080	60

HDMI Resolution:

	Resolution	Refresh Rate (Hz)
PC Timing	640x480	60
	800x600	60
	1024x768	60
	1280x768	60
	1920x1080	60
Video Timing	640x480	60
	1280x720	60
	1920x1080	60
	720x480 (4:3)	60
	720x480 (16:9)	60

APPENDIX

DP Resolution:

	Resolution	Refresh Rate (Hz)
PC Timing	640x480	60
	800x600	60
	1024x768	60
	1280x768	60
	1920x1080	60
Video Timing	640x480	60
	1280x720	60
	1920x1080	60
	720x480 (4:3)	60
	720x480 (16:9)	60

6.3 Cleaning

Caution When Using the Display

- Do not bring your hands, face or objects close to the ventilation holes of the display. The top of the display is usually very hot due to the high temperature of exhaust air being released through the ventilation holes. Burns or personal injuries may occur if any body parts are brought too close. Placing any object near the top of the display could also result in heat related damage to the object as well as the display itself.
- Be sure to disconnect all cables before moving the display. Moving the display with its cables attached may damage the cables and thus cause fire or electric shock.
- Disconnect the power plug from the wall outlet as a safety precaution before carrying out any type of cleaning or maintenance procedure.

Front Panel Cleaning Instructions

- The front of the display has been specially treated. Wipe the surface gently using only a cleaning cloth or a soft, lint-free cloth.
- If the surface becomes dirty, soak a soft, lint-free cloth in a mild detergent solution. Wring the cloth to remove excess liquid. Wipe the surface of the display to remove dirt. Then use a dry cloth of the same type to dry.
- Do not scratch or hit the surface of the panel with fingers or hard objects of any kind.
- Do not use volatile substances such as insert sprays, solvents and thinners.

Cabinet Cleaning Instructions

- If the cabinet becomes dirty, wipe the cabinet with a soft, dry cloth.
- If the cabinet is extremely dirty, soak a lint-free cloth in a mild detergent solution. Wring the cloth to remove as much moisture as possible. Wipe the cabinet. Use another dry cloth to wipe over until the surface is dry.
- Do not allow any water or detergent to come into contact with the surface of the display. If water or moisture gets inside the unit, operating problems, electrical and shock hazards may result.
- Do not scratch or hit the cabinet with fingers or hard objects of any kind.
- Do not use volatile substances such as insert sprays, solvents and thinners on the cabinet.
- Do not place anything made from rubber or PVC near the cabinet for any extended periods of time.

APPENDIX

6.4 Troubleshooting

Symptom	Possible Cause	Remedy
No picture is displayed	<ul style="list-style-type: none"> The main power switch on the side of the display is not switched on. The selected input has no connection. The display is in power saving mode. 	<ol style="list-style-type: none"> 1 Plug in the power cord. 2 Make sure the Main Power switch is switched on. 3 Connect a signal connection to the display.
Interference displayed on the display or audible noise is heard	Caused by surrounding electrical appliances or fluorescent lights.	Move the display to another location to see if the interference is reduced.
Color is abnormal	The signal cable is not connected properly.	Make sure that the signal cable is attached firmly to the bottom of the display.
Picture is distorted with abnormal patterns	<ul style="list-style-type: none"> The signal cable is not connected properly. The input signal is beyond the capabilities of the display. 	<ul style="list-style-type: none"> Make sure that the signal cable is attached firmly. Check the video signal source to see if it is beyond the range of the display. Please verify its specifications with this display's specification section.
Can hear sound, but no picture	Improperly connected source signal cable.	Make sure that both video inputs and sound inputs are correctly connected.
Can see picture but no sound is heard	<ul style="list-style-type: none"> Improperly connected source signal cable. Volume is turned all the way down. MUTE function is turned on. No external speaker connected. 	<ul style="list-style-type: none"> Make sure that both video and sound inputs are correctly connected. Press the + or - button on the remote control to hear the sound. Switch the MUTE function off by using the MUTE button on the remote control. Connect the external speakers and adjust the volume to a suitable level.
Some picture elements do not light up	Some pixels of the display may not turn on.	This display is manufactured using an extremely high level of precision technology: however, sometimes some pixels of the display may not display. This is not a malfunction.
After-Images can still be seen on the display after the display is powered off. (Examples of still pictures include logos, video games, computer images, and images displayed in 4:3 normal mode)	A still picture is displayed for an over extended period of time.	Do not allow a still image to be displayed for an extended period of time as this can cause a permanent after-image to remain on the display.

APPENDIX

6.5 Transporting the LCD Display

To transport the LCD display for repair or shipment, place the display in its original packaging carton.

- 1 Place the LCD display inside the supplied protective bag (a).
- 2 Place the LCD display down in the lower box (b).
- 3 Place the foam cushions (c) of the LCD display for protection.
- 4 Put all the accessories in the box (if necessary).
- 5 Place the upper box (d) on the LCD display.
- 6 Secure the upper box to the lower box with the supplied locks (e). Then close and tape the upper box.

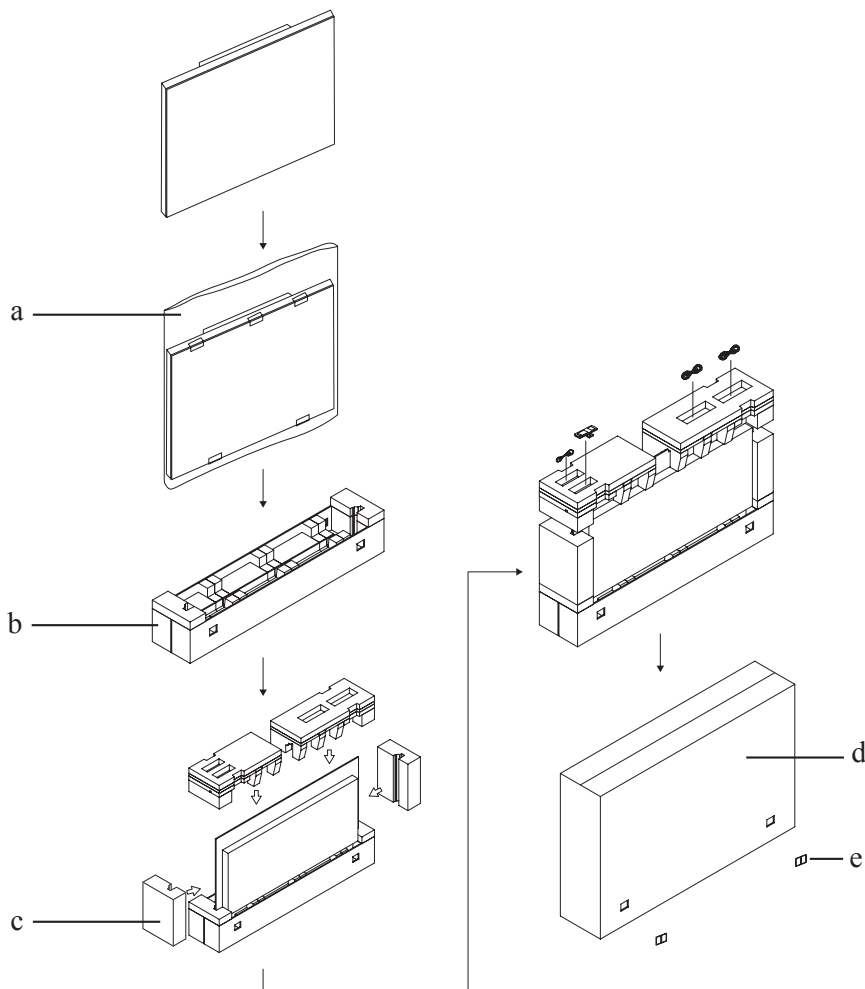

CHAPTER 6: SPECIFICATIONS

6.1 Display Specifications

PO-5502		
Panel	Panel Type	LED-Backlit TFT LCD (VA Technology)
	Panel Size	55"
	Max. Resolution	FHD 1920 x 1080
	Pixel Pitch	0.630 mm
	Brightness	2500 cd/m ²
	Contrast Ratio	4000:1
	Viewing Angle (H/V)	178°/178°
	Display Colour	16.7M
	Response Time	5 ms
	Surface Treatment	Anti-Reflection Treatment (Reflectance <1.45%), 3H
Frequency (H/V)	H Freq.	30 kHz-74 kHz
	V Freq.	56 kHz-76 kHz
Input	DisplayPort	x 1
	HDMI	1.4 x 2
	VGA	15-Pin D-Sub
External Control	RS232 in	3-Pin D-Sub
	RS232 out	3-Pin D-Sub
Audio	Audio In	Stereo Audio Jack (3.5 mm) x 1
	Audio Out	Stereo Audio Jack (3.5 mm) x 1
Power	Power Supply	Internal
	Power Requirements	AC100-240V, 50/60Hz
	On Mode	236W (On)
	Power Saving Mode	< 0.5W
	Off Mode	< 0.5W
Operating Conditions	Temperature	-10°C-50°C (14°F-122°F)
	Humidity	10%-80% (non-condensing)
Storage Conditions	Temperature	-20°C-60°C (-4°F-140°F)
	Humidity	10%-80% (non-condensing)
Mounting	VESA FPMPMI	Yes (600 x 400 mm)
Dimensions	w/o base (W x H x D)	1235.6 x 706.4 x 108.0 mm (48.7" x 27.8" x 4.3")
	Packaging (W x H x D)	1370 x 282 x 870 mm (53.9" x 11.1" x 34.3")
Weight	w/o base	23.5 kg (51.8 lb)
	Packaging	30.5 kg (67.2 lb)

Note:

- ◆ All specifications are subject to change without prior notice.

SPECIFICATIONS

6.2 Display Dimensions

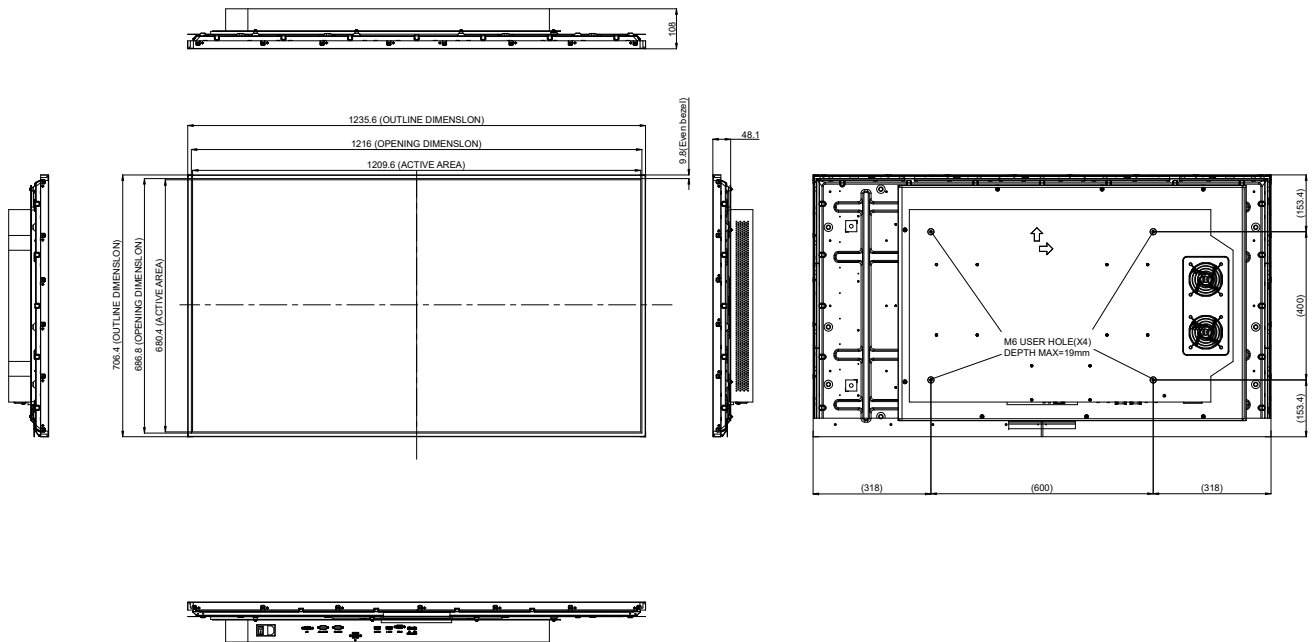

AG Neovo

Company Address: 5F-1, No. 3-1, Park Street, Nangang District, Taipei, 11503, Taiwan.

Copyright © 2022 AG Neovo. All rights reserved.

PO5520_UM_V010